

EXPOSED FASTENING SYSTEM WITH SCREWS OR RIVETS

Parklex Facade may be installed using mechanical fasteners, such as screws or rivets.

The panels are attached to vertical battens.

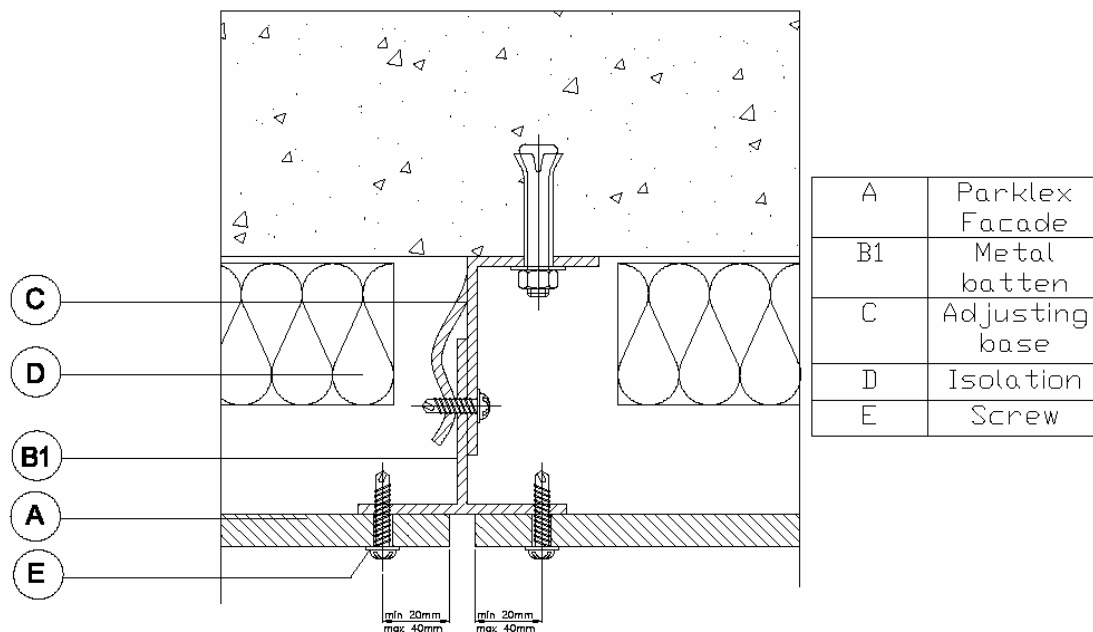

In the event that the wall is not perfectly vertically aligned, support bases may be used to regulate the height of the batten installation.

BASIC PRINCIPLES OF INSTALLATION.

1. Ventilated chamber.

Parklex Facade panels must be installed as a ventilated façade, and therefore they must be separated from the wall face by battens, which are installed vertically, forming a chamber of at least 30 mm.

In the event that some type of insulation will be installed, a double batten structure or a single batten structure with adjustable support bases must be installed, ensuring that the chamber is maintained.

To permit air circulation in the ventilated chamber, the air intake and output must be adequately proportioned.

1.1. Base ventilation

The ventilation at the base must be $\geq 20\text{mm}$. This ventilation space must be left whenever there is a new base, in other words, if the Facade panels are interrupted by windows or other elements.

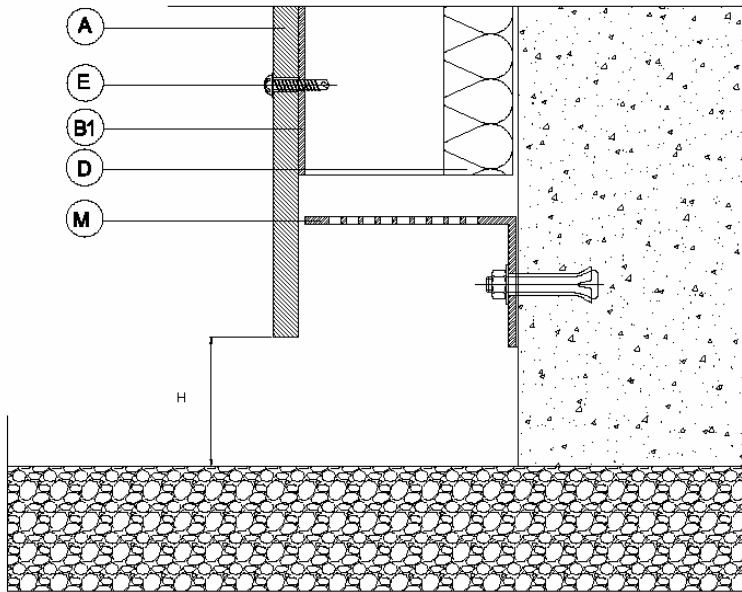

A	Parklex Facade
B1	Metal batten
D	Adjusting base
M	Perforated profile
E	Screw

1.2. Crown ventilation

The ventilation at the crown must be $\geq 20\text{mm}$. As with the base, this ventilation space must be left whenever there is an interruption in the Facade panel face.

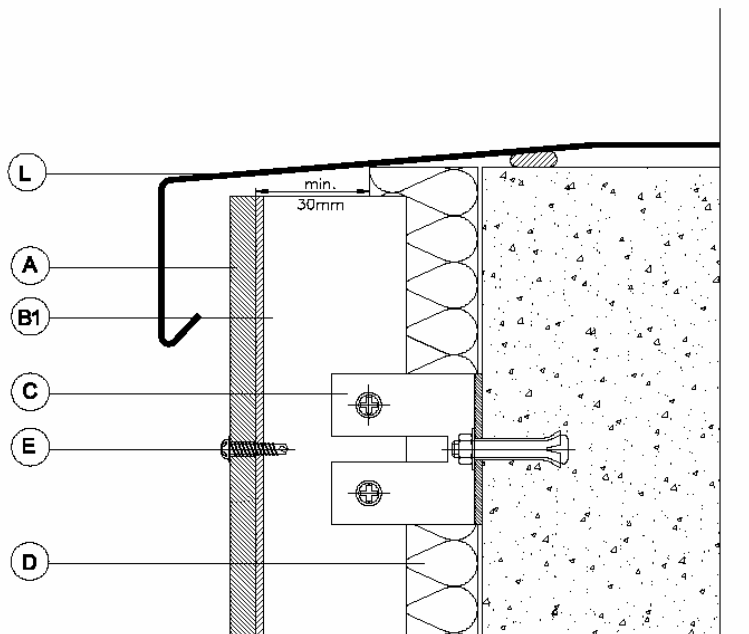

A	Parklex Facade
B1	Metal batten
C	Adjusting base
D	Isolation
E	Screw
L	Metalic plate

1.3. Subdividing the chamber

It is recommended to divide the ventilation chamber vertically to prevent any possible spread of flames in the event of a fire. To do this, create ventilated compartments approximately every 6m.

To prevent the spread of fire, fireproof insulating materials or continuous horizontal firewalls (made from stainless steel, for example) may be used.

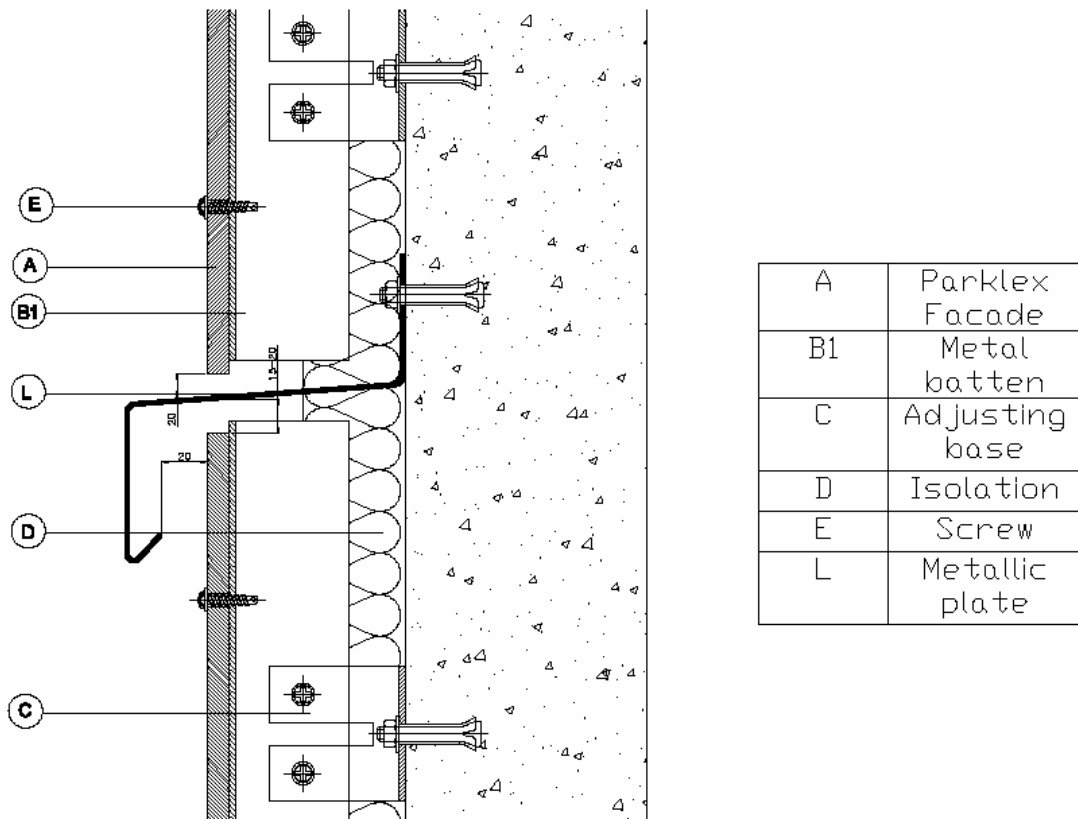

2. Expansion joints

It is necessary to leave peripheral expansion joints between the panels and in places where they meet with other faces so they may absorb any expansion movements.

The thickness of these joints depends on the panel dimensions and aesthetics.

As an example, for panels measuring 2.44 x 1.22 m, these joints must be at least 5 or 6mm, although it is recommended to leave 10mm joints whenever possible.

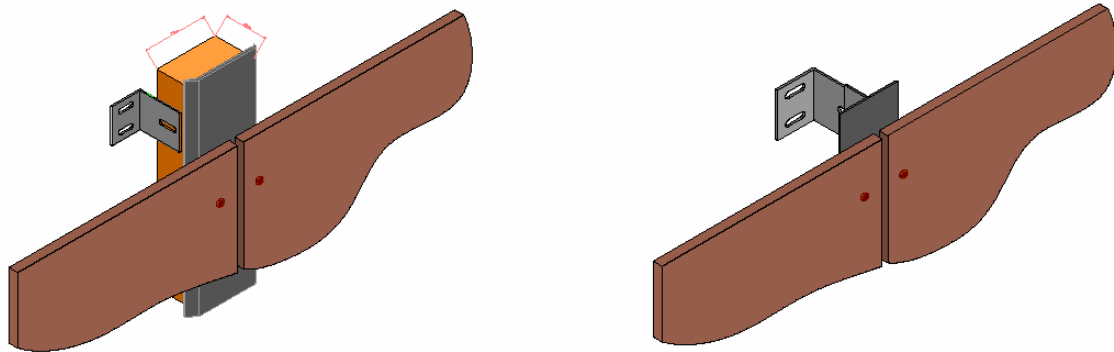

It is recommended not to seal the joints with sealant, since this may lead to an accumulation of dirt around the edges of the panels.

3. Panel movement

Parklex Facade panels are made from natural wood.

Wood is a living material that undergoes dimensional changes due to changes in humidity and temperature.

Therefore, it is important for the fasteners to allow panel movement, permitting their free expansion and contraction.

4. Choosing panel thickness

The panel thickness is selected according to the face being covered (walls, false ceilings and outdoor awnings).

The thickness of a panel influences the distance between the support battens; the greater the thickness, the greater the distance between the battens, although this may vary, depending on the type of installation.

The ideal thickness for external claddings is 8 or 10mm.

Thicknesses of 3 or 6mm are not recommended, except in special cases. If you wish to use these thicknesses, consult the technical department at Composites Gurea.

5. Substructure: wood or metal

To facilitate air circulation behind the panels, a substructure of vertical battens must be installed.

This substructure must be proportioned according to the normal wind load for the area and in such a way that meets all stationary requirements. Likewise, keep in mind the vertical alignment of the façade, the fastening system chosen, the thickness and the dimensions of the Parklex Facade panel being installed. In addition, it must be well protected against corrosion and rotting, regardless of the material or system used.

5.1 Type of batten

- Wood substructure:

If the substructure is built with wood battens, they must be treated. It is recommended to install PVC joints or closed-cell polyethylene foam over the panel support surfaces, as these protect, improve and extend their service life. This type of substructure may be used in dry areas without frequent rains.

- Metal substructure:

If located in rainy or humid areas, we can use metal battens made from galvanized steel or aluminium.

- Metal substructures in areas near the sea:

- In areas that suffer obvious effects from the sea, stainless steel profiles must be used, or those made from appropriate anodized aluminium.

5.2 Vertical alignment

Façades frequently have significant slopes. In these cases, the use of profiles with bases that allow for the adjustment of the vertical alignment is recommended.

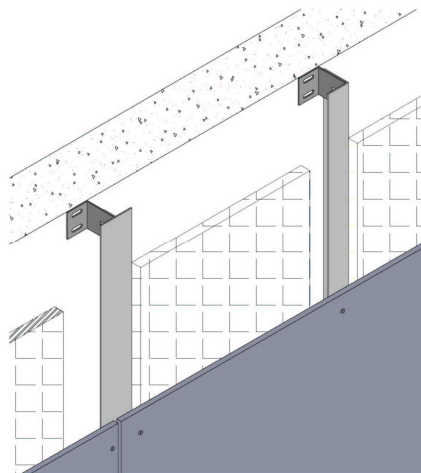

6. Three support points

Parklex Facade panels must be supported by at least three points of support.

The distances between support points depend on the type of fasteners and the thickness of the material. The instructions regarding distances that come with the various fastener systems may be followed, as long as there are at least three points of support in each direction.

7. Installation using a tongue-and-groove system

Panel installation using a tongue-and-groove system is not allowed, as this type of system uses screws with counter-sunk heads. These screws do not allow free panel movement, which is why they are not appropriate for installing Parklex Facade panels.

FASTENERS

Distance between battens:

Thickness	Distance
3 mm.	300 mm.
6 mm.	400 mm.
8 mm.	600 mm.

* as long as there are at least 3 fastening points.

Distance between fasteners:

Thickness	Distance
3 mm.	300 mm.
6 mm.	400 mm.
8 mm.	600 mm.
10 mm.	700 mm.
≥12 mm.	1000 mm.

Drilling the holes:

Parklex Facade panels undergo dimensional variations due to temperature and humidity. These dimensional variations and variations in the structure must be taken into account when drilling the holes.

If using screws, the diameter of the hole must be 2-3mm larger than the diameter of the screw shank, except at one point per panel where it must be equal to it. This fixed point must be as close as possible to the geometric center of the panel. Bevel-headed screws must NEVER be used because they prevent panel movement as the result of dimensional changes.

If using rivets, the diameter of the hole must be 3.5mm larger than the diameter of the rivet shank, except at one point per panel where it must be equal to it. This fixed point must be as close as possible to the geometric center of the panel.

SX3- L12 5,5x28

Floating point

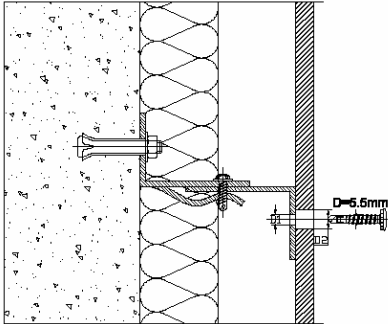

Fixed point

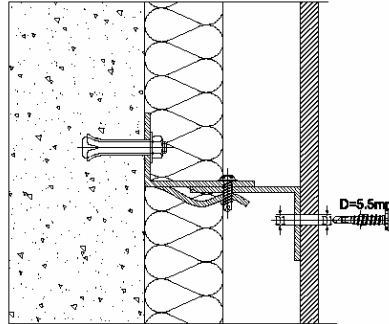

D1	Screw diameter + 0,1 tolerance
D2	8mm

AP16 5x16, 21

Floating point

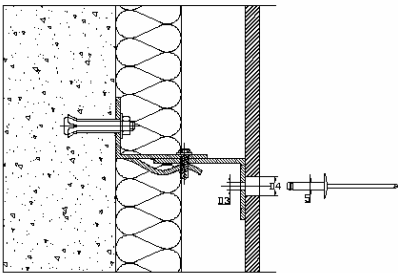

Fixed point

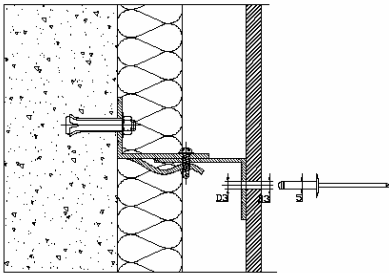

D3	Rivet diameter + 0,1 tolerance
D4	8,5mm

TWS D12 4,8xL

Floating point

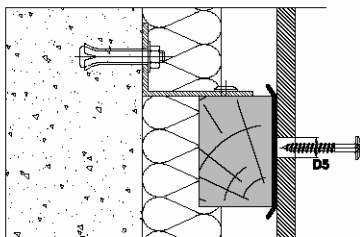

Fixed point

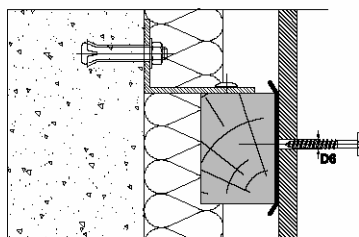

D5	Screw diameter + 0,1 tolerance
D6	7-8mm

Fastening distance from the edges:

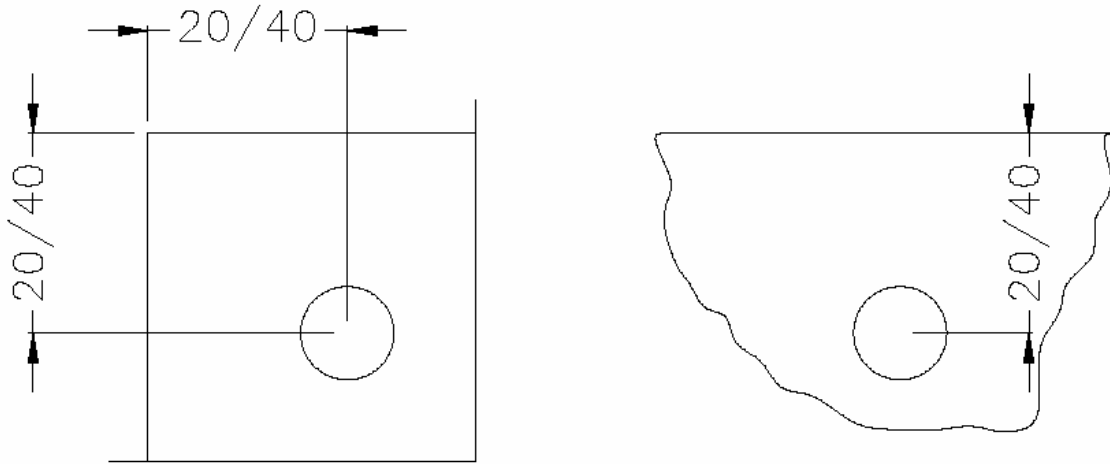

Fastening elements:

Parklex provides lacquered screws and rivets in the same colour as the panel finishes.

Screw for attaching to a wood batten:

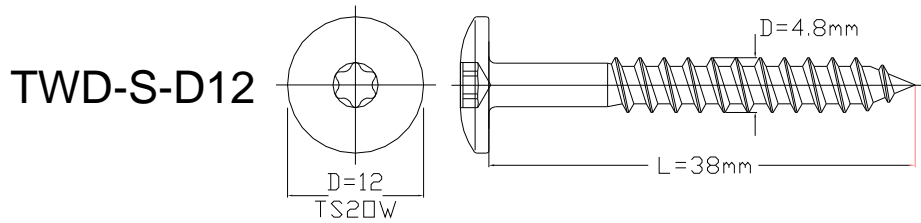

Screw for attaching to a metal batten:

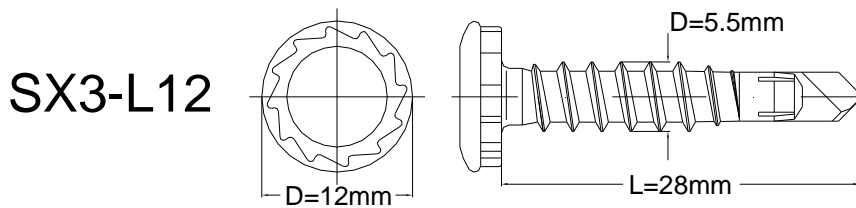

Rivet:

